



ELITE 1500 / 2500
QUICK START GUIDE

LIMITED WARRANTY

Lockin Pty Ltd trading as Haltech warrants the Haltech™ Programmable Fuel Injection System to be free from defects in material or workmanship for a period of **12 months** from the date of purchase.

Proof of purchase, in the form of a bill of sale or receipted invoice, which indicates that the product is within the warranty period, must be presented to obtain warranty service. Lockin Pty Ltd trading as Haltech suggests that the purchaser retain the dealer's dated bill of sale as evidence of the date of retail purchase. If the Haltech™ Programmable Fuel Injection System is found to be defective as mentioned above, it will be replaced or repaired if returned prepaid along with proof of purchase. This shall constitute the sole liability of Lockin Pty Ltd trading as Haltech.

To the extent permitted by law, the foregoing is exclusive and in lieu of all other warranties or representations, either expressed or implied, including any implied warranty of merchantability or fitness.

In no event shall Lockin Pty Ltd trading as Haltech, be liable for special or consequential damages.

WIRING AND SETUP WARNING

If your ignition or fuel system is incorrectly configured and the ECU is powered up, damage to the engine or components may occur. To avoid damage remove the main ignition and injection fuses before powering up for the first time. Re-fit fuses when configuration of the ignition and fuel system is completed and checked in the Elite Software Programmer.

It is good practice to also disconnect when updating firmware within the ECU.

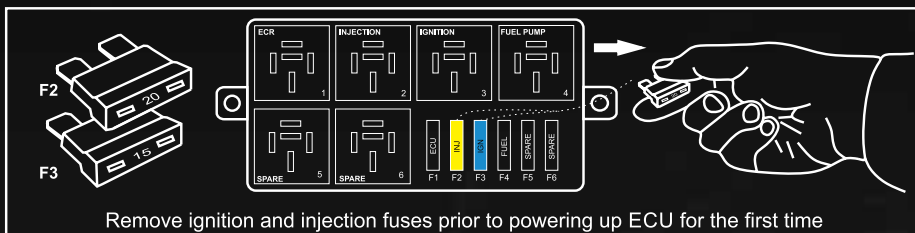

Failure to follow all the warnings and precautions in this manual can lead to damage to engine components and may possibly void your warranty. Incorrect setup of the ECU can also lead to damaged engine components.

Damaged components due to incorrect setup will not be regarded as warranty repairs.

GENERAL INSTALLATION WARNING

Avoid open sparks, flames or operation of electrical devices near flammable substances. Always disconnect the battery cables when doing electrical work on your vehicle.

Do not charge the battery with a 24 Volt truck charger or reverse the polarity of the battery or any charging unit. Do not charge or disconnect the battery with the engine running as this could expose the ECU to an unregulated power supply that could destroy the ECU and other electrical equipment.

All fuel system components and wiring should be mounted away from heat sources, shielded if necessary and well ventilated. Disconnect the Haltech ECU from the electrical system whenever doing any welding on the vehicle by unplugging the wiring harness connector from the ECU.

After completing the installation, make sure that there are no fuel leaks, and no wiring left un-insulated in case a spark or short-circuit occurs and causes a fire. Also make sure that you follow all proper workshop safety procedures. If you're working underneath a jacked-up car, always use safety stands!



Elite 1500 / 2500 Quick Start Guide

Congratulations on your purchase of an Elite Series Haltech Engine Management System.

This *fully programmable* product opens the door to virtually limitless performance modifications and tuning of your vehicle.

Programmable systems allow you to extract all the performance from your engine by delivering precisely the required amount of fuel and ignition timing that your engine requires for maximum output under all operating conditions.

This quick start guide will walk you through installation of a Haltech Elite Series ECU into a vehicle.

This guide is accompanied by the Help information located on the Haltech Nexus Software Programmer (NSP) package provided on the USB key with the ECU that you or your tuner will need to refer to before completing your installation and configuration.

More information is available from the Haltech website

WARNING - HALTECH OFF-ROAD USAGE POLICY

It may be unlawful to tamper with your vehicle's emissions equipment. This ECU is designed and sold for Sanctioned Offroad/ Competition Non-Emissions Controlled Vehicles only. Using this product for street / road use on public highways may be prohibited by law. It is the responsibility of the installer and/or user of this product to ensure compliance with all applicable local and federal laws and regulations. Please check with your local vehicle authority before using this product.

ECU OVERVIEW

1 Main Connector A (34 pin)

2 Main Connector B (26 pin)

3 Internal MAP Sensor

4 Status LED

5 Power LED

6 Communications
USB Port

7 Auxiliary CAN Bus Port

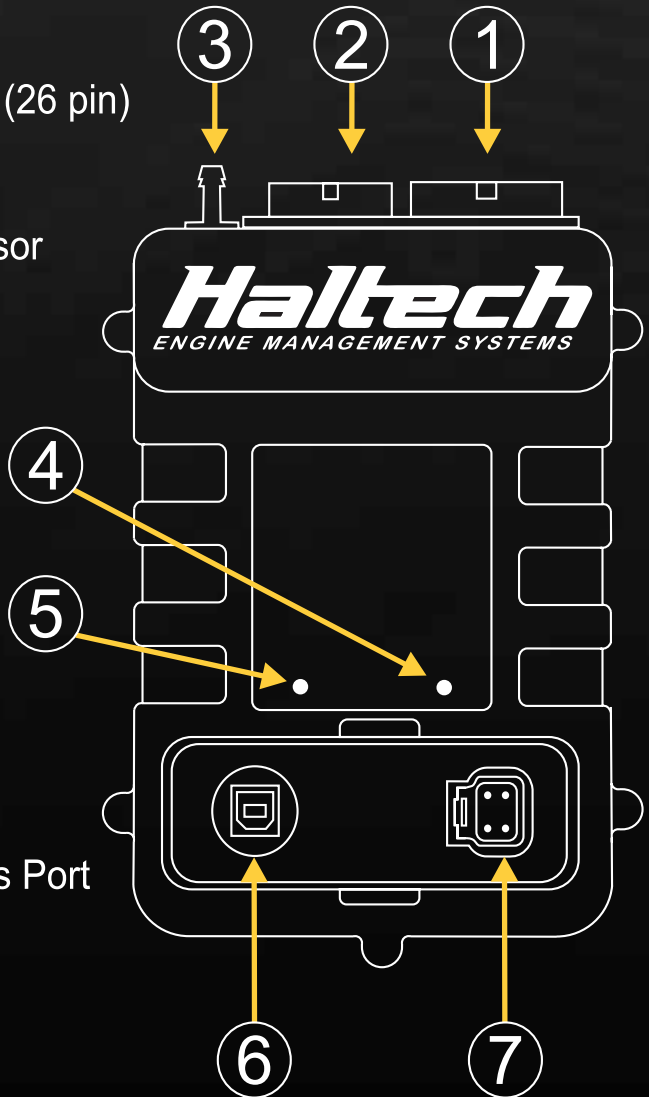

NEXUS SOFTWARE PROGRAMMER INSTALLATION

MINIMUM SYSTEM REQUIREMENTS

Operating System: Windows XP / Vista / 7 / 8 / 10
Processor: Dual Core 2GHz
RAM: 2GB
Video Card: 128MB graphics card with 3D acceleration
USB: 1.1
HDD Space: 300MB
Min Screen Resolution: 1024 x 768 pixels

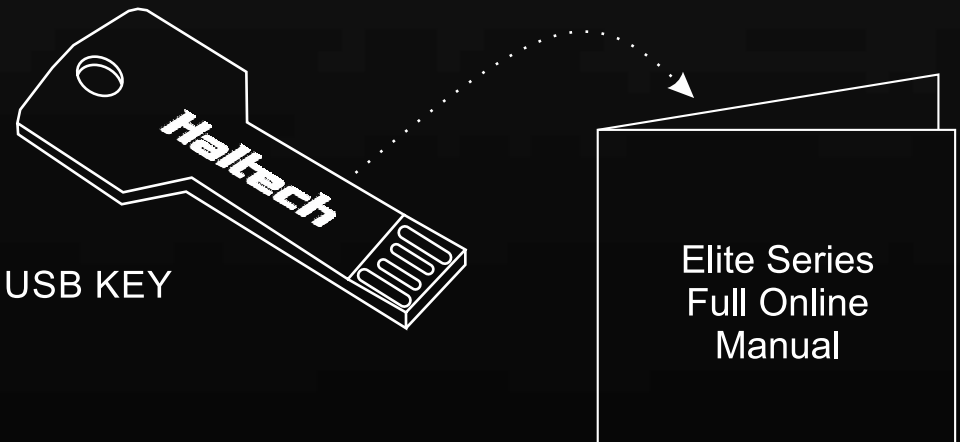

INSTALLATION

Installation of the Nexus Software Programmer onto your PC is performed similar to any other Windows software package. Installation is outlined below.

1. Insert the included Haltech USB key into your computer.

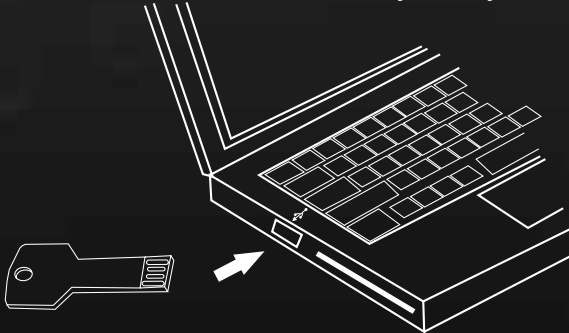

2. Open “My Computer” and see what drives are shown. The Haltech USB Key should be shown as a device with removable storage icon named “HALTECH”. Double click on the device icon to open the root directory of the Haltech USB Key.
3. Double click on the “Start Haltech Resource.exe” file to run the Haltech Resource Centre. A browser window will appear and you will need to agree to the terms stated before progressing. Read the disclaimer and click on “AGREE” if you agree. You will now be able to access all the information contained on the Haltech USB Key.
4. To download and install the Nexus Software Programmer click the software link. You will be prompted to install the software. Click “Install” to install the software to your computer.
5. Follow the software prompts to complete the Nexus Software Programmer installation. Please note DirectX is required for correct operation of the Nexus Software Programmer, the installer package will check your system and prompt for installation of DirectX if not already installed. Follow the prompts to complete.

ELITE SERIES INTEGRATED HELP MANUAL

A comprehensive instruction manual is available within the Nexus Software Programmer which contains detailed information regarding installation, setup and tuning of your Elite Series of ECU.

To access, start the Haltech Nexus Software Programmer and press the "F1" key on your computer.



CRANK / CAM

(TRIGGER) / (HOME)

OVERVIEW

The crank and cam position sensors are required so that the ECU has the necessary information available to it to determine engine speed and position at any point in time.

Generally two sensors are required - a cam position and crank position, however many cars will have just a cam position sensor that is capable of giving the ECU enough information to run the engine correctly. Vehicles that have a crank position sensor only are not capable of determining the difference between compression stroke and exhaust stroke and therefore are not suitable for sequential fire applications. In this case a cam position sensor may need to be added.

There are generally 2 types of crank / cam sensor signals

- Hall Effect signal (0-5V Digital square wave signal)
Generally hall effect sensors have 3 wires - a power supply (could be 5V ,8V or 12V), a ground and a signal out wire.

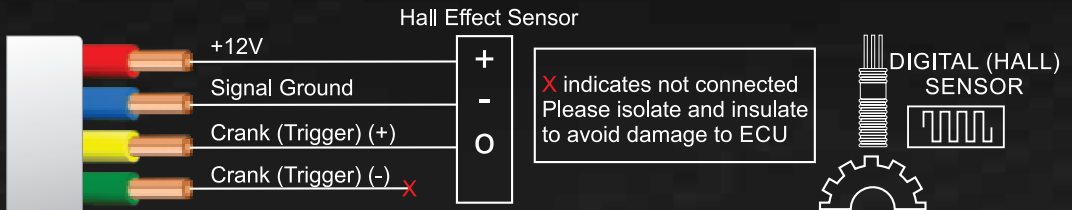

- Reluctor signal (Analogue style signal)
This type of sensor will generally only have two wires, signal Positive (+) and signal negative (-)

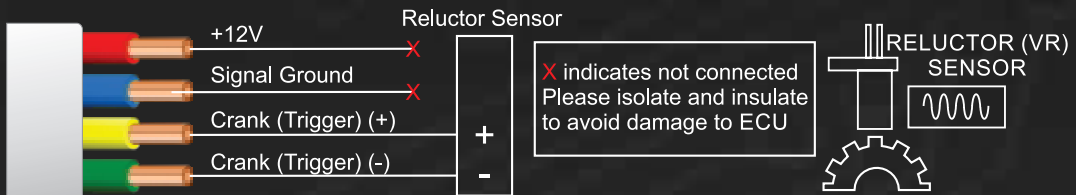

AVI

ANALOGUE VOLTAGE INPUTS

WITH SELECTABLE PULL-UP TO 5V

OVERVIEW

Analogue Voltage Inputs are inputs to the ECU that accept variable voltage signals from 0V to +5V such as signals from pressure, temperature and fuel level sensors.

AVI inputs can tolerate a maximum input voltage of 20V.

These inputs can also accept switched inputs that change between two different voltage levels. The *On Voltage* and *Off Voltage* define what the thresholds are between the on and off states.

The voltage can be viewed as a channel in the Nexus Software Programmer to determine the thresholds for a switched input.

Common examples of switched inputs include A/C Request switch and intercooler spray switch.

AVI-1 and AVI-6 are inputs which are optimally designed to be used with Narrowband O₂ sensors due to the AVI having a high input impedance which minimises the ECU's load on the 0V to 1V signal produced by most Narrowband O₂ sensors.

When Narrowband O₂ sensors are not used these inputs can be setup and used as any function that is available to the input.

AVI's have a software selectable 1K pull-up resistor to 5V, which can be enabled or disabled with a check box within the setup page. Pull-up resistors are generally enabled for temperature related sensors and switched to ground inputs.



SPI

SYNCHRONISED PULSED INPUTS

OVERVIEW

Synchronised Pulsed Inputs are capable of measuring the position, duty cycle, frequency or state of a signal. These inputs are suitable for sensors such as cam position sensors, fuel composition sensors, road speed sensors and flat shift switch.

Synchronised Pulsed Inputs are compatible with digital (hall effect or optical) and reluctor (analogue) based sensors, have a maximum input voltage rating of 25VDC and can measure up to 50KHz Maximum frequency.

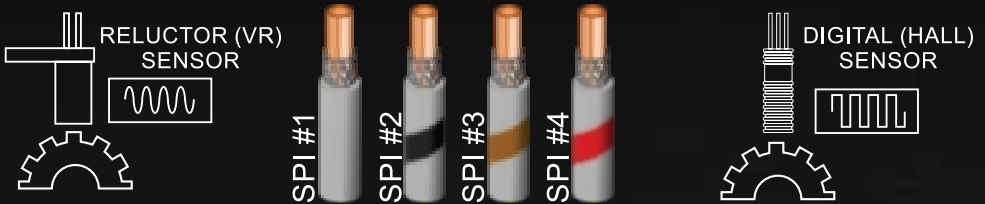

KNOCK

KNOCK DETECTION

OVERVIEW

A knock sensor detects engine knock and sends a voltage signal to the ECU. The Elite Series ECU uses the knock sensor signal to modify ignition timing if knocking occurs. Knock detection can be performed by the Elite Series ECU by installing a compatible piezoelectric knock sensor mounted to the engine block.

* **KNOCK #2 available to Elite 2500 ECU Only**

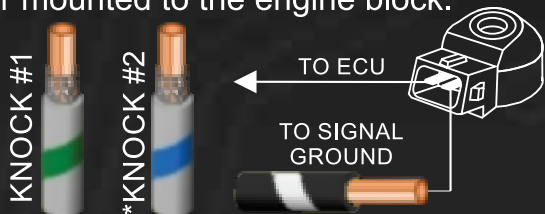

DPO

DIGITAL PULSED OUTPUTS

OVERVIEW

Digital Pulsed Outputs are capable of producing pulsed waveforms with varying duty and frequency.

DPO's can be used to control various devices such as thermofans, shift lights, bypass air control valves, boost control solenoids etc. When a Digital Pulsed Output is activated by the ECU the output will switch to ground. Solenoid valves and shift lights etc can be run directly from the output, however high current devices such as thermo fans and additional fuel pumps must be activated through a relay, this way the DPO is only switching a relay and not a high current draw device.

The Pull-Up Voltage specifies the waveforms maximum voltage output ie 0 to 12V, 0 to 8V or 0 to 5V.

The Pull-Up Voltage specific to each DPO is outlined below:

DPO 1: User definable 0-12V Pull-Up

DPO 2: Fixed 5V Pull-Up

DPO 3 to 6: Fixed 12V Pull-Up

OUTPUT: Ground @ 1A Max Current

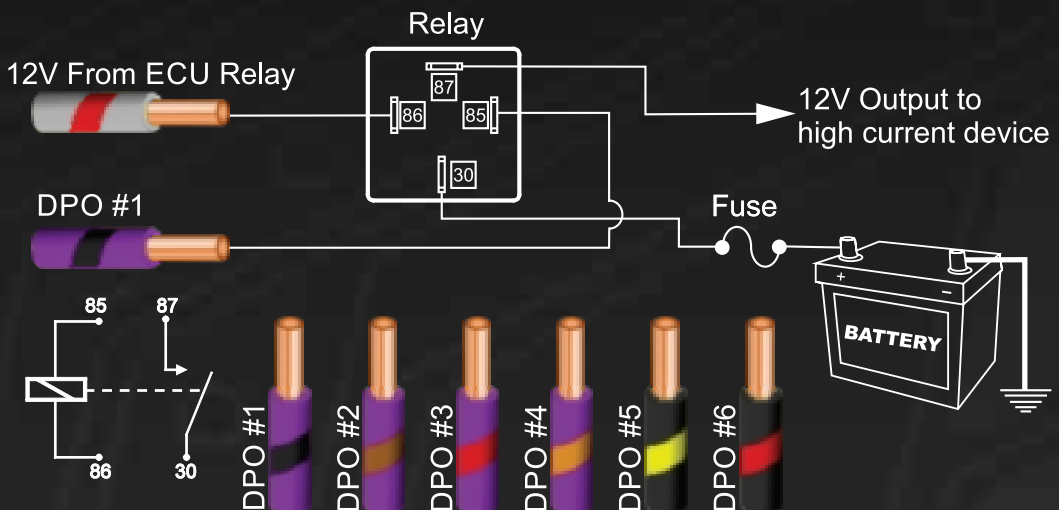

IGNITION

* IGNITION 1 - 8

OVERVIEW

Ignition outputs must be connected directly to an ignition module to control the ignition of the vehicle. Do not connect directly to a coil without an internal or external ignition module as doing this will damage the ECU.

The ECU ignition output produces a signal between 12V and ground to control the ignition module allowing the charging and firing of the coil.

When not used for ignition, these outputs can be used as Digital Pulsed Outputs (DPO) capable of switching 1A to ground.

WARNING

Connecting the ECU to an ignition module before setting the ignition firing edge correctly may damage the module and coils, therefore it is advised to disconnect the module or the main ignition fuse until the unit has been setup and configured.

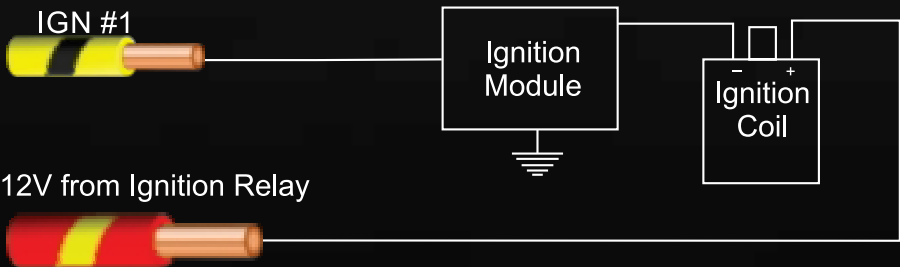

* IGN #5 / IGN #6 / IGN #7 / IGN #8 available to Elite 2500 ECU only



INJECTION

* INJECTORS 1 - 8

OVERVIEW

All Injectors are wired directly to the ECU's corresponding cylinder output pins. When an injection event occurs the ECU will ground the output pin opening the injector.

All injectors are wired to a common +12V supply from the injector relay located within the fuse box.

When not used for injection, these outputs can be used as Digital Pulsed Outputs (DPO) capable of switching 1A Max to ground.

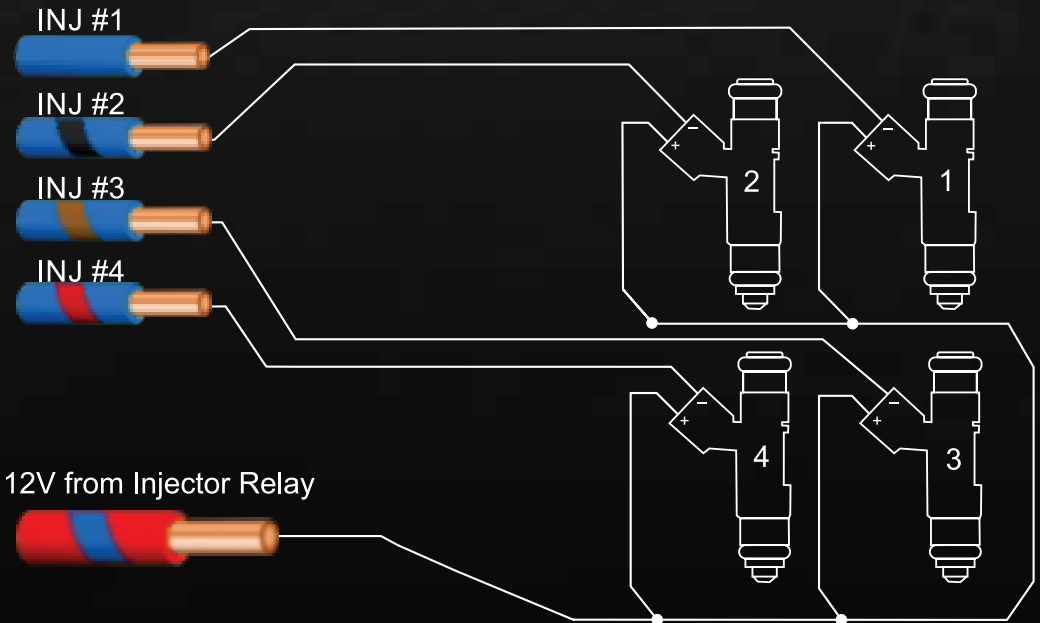

*** INJ #5 / INJ #6 / INJ #7 / INJ #8 available to Elite 2500 ECU only**

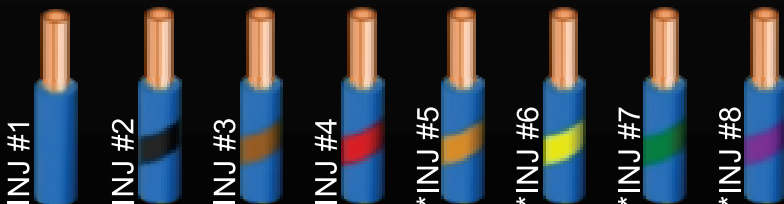

DBW

DRIVE BY WIRE THROTTLE CONTROL

OVERVIEW

The Elite Series ECU's can control most OEM electronic throttles. Drive by wire throttle control is an advanced feature of the Elite Series ECU's. It is recommended that a brake switch is wired to an input on your ECU as an additional safety feature. Please consult the help information contained within the Nexus Software Programmer for extensive information on compatibility, wiring, setup and calibration.

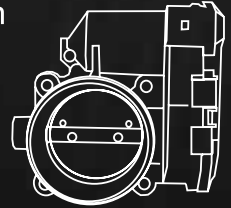

STEPPER

STEPPER MOTOR CONTROL

OVERVIEW

The Elite Series ECU's have 4 wires capable of controlling most OEM Stepper Motor type Idle Speed Control Valves (4 & 6 wire) and Oil Metering Pumps found on rotary engines. Please consult the help information contained within the Elite Software Programmer for more information on wiring and setup. Stepper outputs can also be used as Digital Pulsed Outputs (DPO) capable of sinking 1A Max to ground and driving 1A Max to 12V.

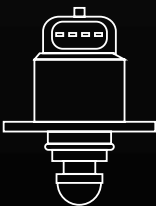

STEPPER1 P1



STEPPER1 P2



STEPPER1 P3



STEPPER1 P4

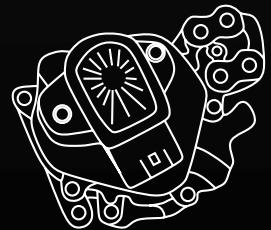

MAIN POWER

POWERING UP THE ECU

OVERVIEW

There are two types of harness's available for each product. Premium Harness, which includes a pre-terminated fuse and relay box, and the Basic Harness, which does not.

Please refer to your specific harnesses wiring diagram for more information. Main connections are outlined below:

Connections available to Premium Harness only



12V Input - Connect directly to battery + terminal



12V Input - Connect directly to battery + terminal

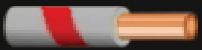

12V Sensor/Relay Supply - To sensors or relay coils requiring 12V



12V Input - Connect directly to battery + terminal



12V Ignition Input - Connect to 12V switched input



12V Supply for Fuel Injectors - Connect to fuel injectors

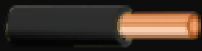

Battery Ground Input - Connect to battery - terminal

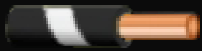

Signal Ground Output - To sensors requiring a ground



5V Sensor Supply - To sensors requiring 5V



8V Sensor Supply - To sensors requiring 8V

WARNING

To avoid damage to the ignition components and engine, disconnect the main ignition and injection fuses from the fuse box prior to powering up and configuring for the first time. Ensure your engine block is grounded via a ground strap connected directly to the battery - terminal or chassis

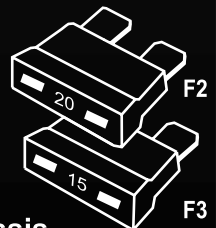

NEED MORE HELP?

Technical Support Australia (Head Office)

Email: support@haltech.com

Phone: +61 2 9729 0999

Technical Support USA

Email: usasupport@haltech.com

Phone: +1 888 298 8116

Technical Support NZ

Email: nz_support@haltech.com

Phone: +64 988 706 16

Technical Support EU

Email: eu_support@haltech.com

Phone: +43 720 883 968

Technical Support UK

Email: uk_support@haltech.com

Phone: +44 121 285 6650



SCAN THIS CODE

For more information
on Haltech products

