



ELITE 550 / 750  
QUICK START GUIDE

# LIMITED WARRANTY

Lockin Pty Ltd trading as Haltech warrants the Haltech™ Programmable Fuel Injection System to be free from defects in material or workmanship for a period of **12 months** from the date of purchase.

Proof of purchase, in the form of a bill of sale or receipted invoice, which indicates that the product is within the warranty period, must be presented to obtain warranty service. Lockin Pty Ltd trading as Haltech suggests that the purchaser retain the dealer's dated bill of sale as evidence of the date of retail purchase. If the Haltech™ Programmable Fuel Injection System is found to be defective as mentioned above, it will be replaced or repaired if returned prepaid along with proof of purchase. This shall constitute the sole liability of Lockin Pty Ltd trading as Haltech.

To the extent permitted by law, the foregoing is exclusive and in lieu of all other warranties or representations, either expressed or implied, including any implied warranty of merchantability or fitness.

In no event shall Lockin Pty Ltd trading as Haltech, be liable for special or consequential damages.

## WIRING AND SETUP WARNING

If your ignition or fuel system is incorrectly configured and the ECU is powered up, damage to the engine or components may occur. To avoid damage disconnect ignition coils and injectors before powering up for the first time. Re-connect when configuration of the ignition and fuel system is completed and checked in the Elite Software Programmer.

It is good practice to also disconnect when updating firmware within the ECU.

Failure to follow all the warnings and precautions in this manual can lead to damage to engine components and may possibly void your warranty. Incorrect setup of the ECU can also lead to damaged engine components.

Damaged components due to incorrect setup will not be regarded as warranty repairs.

## GENERAL INSTALLATION WARNING

Avoid open sparks, flames or operation of electrical devices near flammable substances. Always disconnect the battery cables when doing electrical work on your vehicle.

Do not charge the battery with a 24 Volt truck charger or reverse the polarity of the battery or any charging unit. Do not charge or disconnect the battery with the engine running as this could expose the ECU to an unregulated power supply that could destroy the ECU and other electrical equipment.

All fuel system components and wiring should be mounted away from heat sources, shielded if necessary and well ventilated. Disconnect the Haltech ECU from the electrical system whenever doing any welding on the vehicle by unplugging the wiring harness connector from the ECU.

After completing the installation, make sure that there are no fuel leaks, and no wiring left un-insulated in case a spark or short-circuit occurs and causes a fire. Also make sure that you follow all proper workshop safety procedures. If you're working underneath a jacked-up car, always use safety stands!



# Elite 550 / 750

## Quick Start Guide

Congratulations on your purchase of an Elite Series Haltech Engine Management System.

This *fully programmable* product opens the door to virtually limitless performance modifications and tuning of your vehicle. Programmable systems allow you to extract all the performance from your engine by delivering precisely the required amount of fuel and ignition timing that your engine requires for maximum output under all operating conditions.

This quick start guide will walk you through installation of a Haltech Elite Series ECU into a vehicle.

This guide is accompanied by the Help information located on the Haltech Elite Software Programmer package provided on the CD with the ECU that you or your tuner will need to refer to before completing your installation and configuration.

More information is available from the Haltech website

[www.haltech.com.au](http://www.haltech.com.au)

SCAN THIS CODE  
For more information  
on Haltech products



# ECU OVERVIEW

## Main Features

- Waterproof Case (IP67) (with USB Cover Fitted)
- Fuel Injection Outputs (0-8A Peak / 0-2A Hold)
- Ignition Outputs
- 2 x Engine Position Inputs with extensive trigger type support
- Digital Pulsed Inputs
- 5 x Digital Pulsed Outputs
- 1 x Internal 3Bar MAP Sensor
- 2 x Analogue Voltage Inputs
- 1 x Throttle Position Input
- 1 x Coolant Temperature Input
- 1 x Air Temperature Input
- 1 x CAN Connection (Haltech CAN Only)

**1** Main Connector

**2** Internal MAP Sensor

**3** Communications  
USB Port

**4** Status LED

**5** Power LED

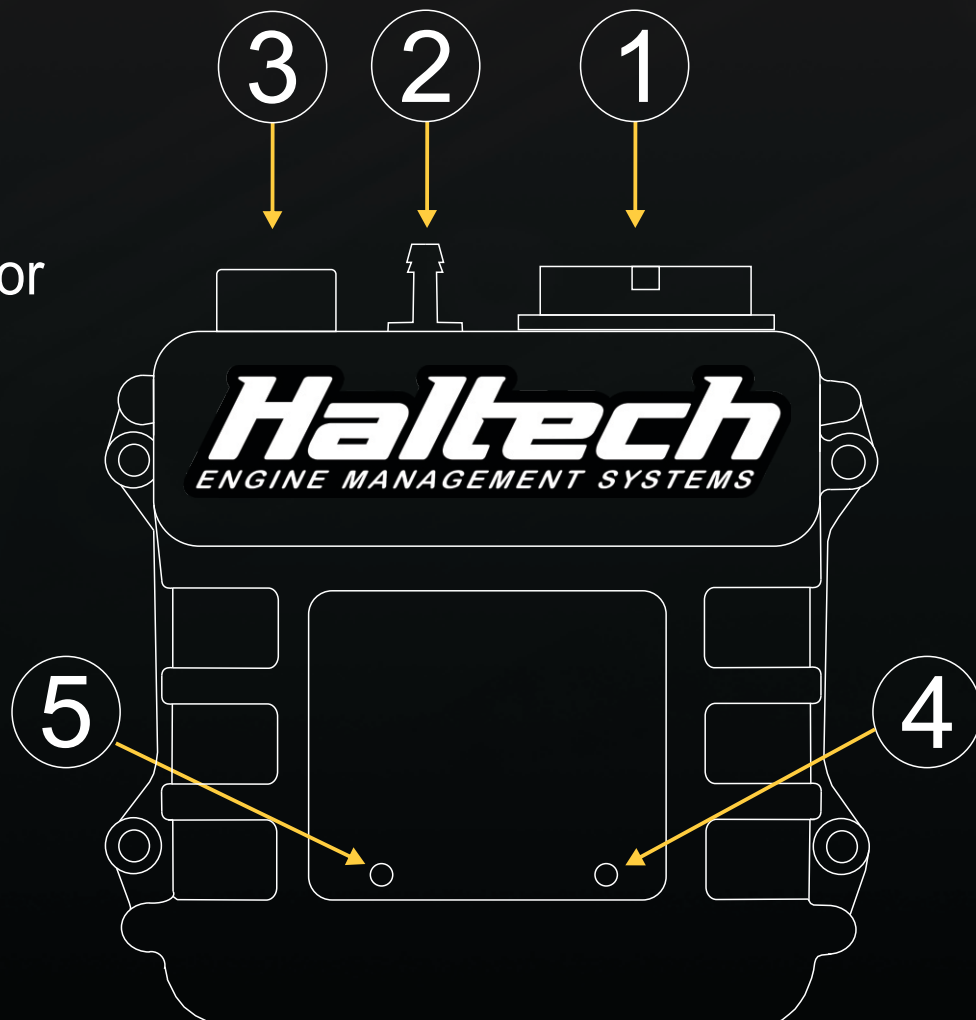

# ELITE SOFTWARE PROGRAMMER INSTALLATION

## MINIMUM SYSTEM REQUIREMENTS

Operating System:	Windows XP / Vista / 7 / 8 /10
Processor:	Dual Core 2GHz
RAM:	2GB
Video Card:	128MB graphics card with 3D acceleration
USB:	1.1
HDD Space:	300MB
Min Screen Resolution:	1024 x 768 pixels



# INSTALLATION

Installation of the Elite Software Programmer onto your PC is performed similar to any other Windows software package. Installation is outlined below.

1. Insert the included Haltech CD into your computer
2. Open “My Computer” and see what drives are shown. The Haltech Resource CD should be shown as a device with removable storage icon named “HALTECH”. Double click on the device icon to open the root directory of the Haltech Resource.
3. Double click on the “Start Haltech Resource.exe” file to run the Haltech Resource Centre. A browser window will appear and you will need to agree to the terms stated before progressing. Read the disclaimer and click on “AGREE” if you agree. You will now be able to access all the information contained on the Haltech Resource CD.
4. To download and install the Elite Software Programmer click on the software link. You will be prompted to install the software. Click “Install” to install the software to your computer.
5. Follow the software prompts to complete the Elite Software Programmer installation. Please note DirectX is required for correct operation of the Elite Software Programmer, the installer package will check your system and prompt for installation of DirectX if not already installed. Follow the prompts to complete.
6. Alternatively the software package can be directly downloaded and installed from the Haltech website [www.haltech.com.au](http://www.haltech.com.au)

# ELITE SERIES INTEGRATED HELP MANUAL

A comprehensive instruction manual is available within the Elite Software Programmer which contains detailed information regarding installation, setup and tuning of your Elite Series of ECU.

To access, start the Haltech Elite Software Programmer and press the "F1" key on your computer.



# CRANK / CAM

## (TRIGGER) / ( HOME )

### OVERVIEW

The crank and cam position sensors are required so that the ECU has the necessary information available to it to determine engine speed and position at any point in time.

Generally two sensors are required - a cam position and crank position, however many cars will have just a cam position sensor that is capable of giving the ECU enough information to run the engine correctly. Vehicles that have a crank position sensor only are not capable of determining the difference between compression stroke and exhaust stroke and therefore are not suitable for sequential fire applications. In this case a cam position sensor may need to be added.

There are generally 2 types of crank / cam sensor signals

- Hall Effect signal (0-5V Digital square wave signal)  
Generally hall effect sensors have 3 wires - a power supply (could be 5V ,8V or 12V), a ground and a signal out wire.

Hall Effect Sensor

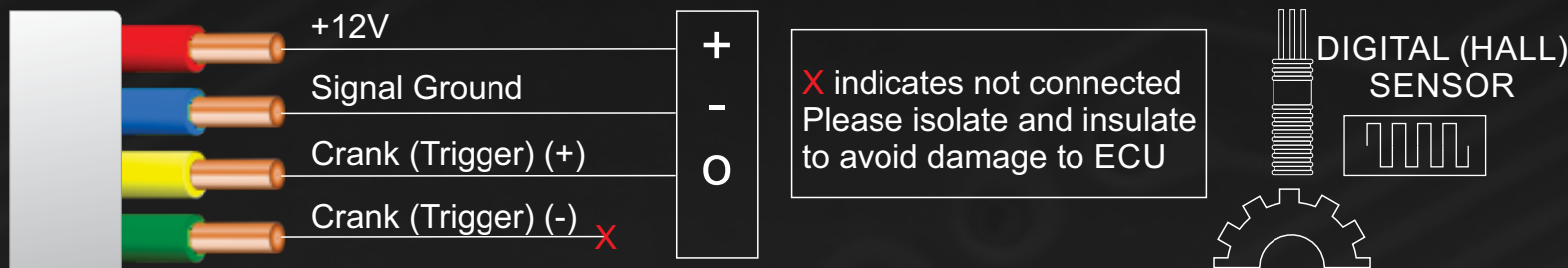

- Reluctor signal (Analogue style signal)  
This type of sensor will generally only have two wires, signal Positive (+) and signal negative (-)

Reluctor Sensor

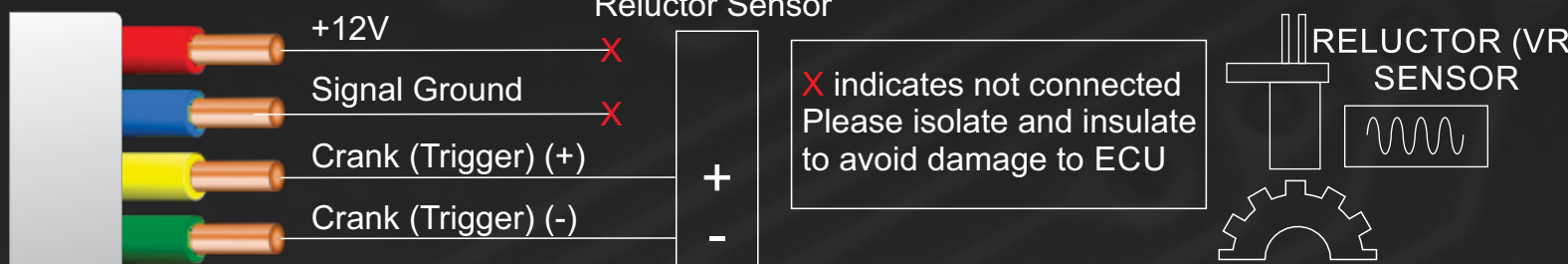



# AVI

## ANALOGUE VOLTAGE INPUTS

### OVERVIEW

Analogue Voltage Inputs are inputs to the ECU that accept variable voltage signals from 0V to +5V such as signals from pressure, temperature and fuel level sensors.

AVI inputs can tolerate a maximum input voltage of 20V.

These inputs can also accept switched inputs that change between two different voltage levels. The *On Voltage* and *Off Voltage* define what the thresholds are between the on and off states.

The voltage can be viewed as a channel in the Elite Software Programmer to determine the thresholds for a switched input.

Common examples of switched inputs include A/C Request switch and intercooler spray switch.

AVI #4 and #5 have a software selectable 1K pull-up resistor to 5V, which can be enabled or disabled with a check box within the setup page. Pull-up resistors are generally enabled for temperature related sensors. Some examples of sensors are shown below. Please refer to the individual sensor notes supplied with the sensors for specific wiring information.

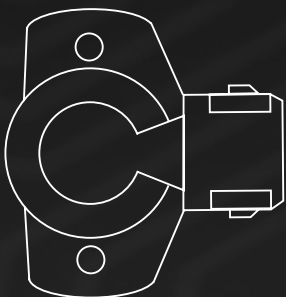

Throttle Position



Temperature

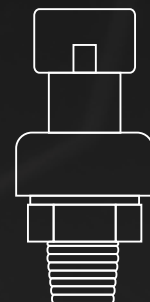

Pressure

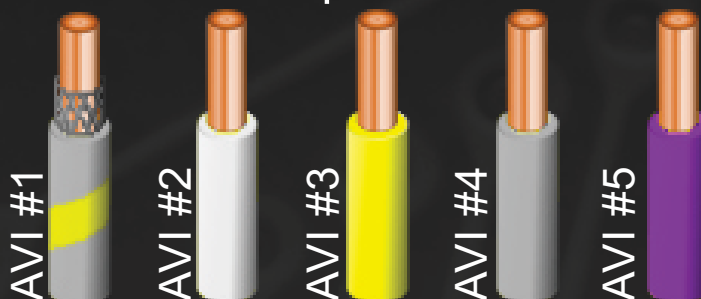

# DPI

## DIGITAL PULSED INPUTS

### OVERVIEW

Digital Pulsed Inputs are capable of measuring the duty cycle, frequency or state of a signal. These inputs are suitable for sensors and switches such as fuel composition sensors, road speed sensors, A/C Request switch and flat shift switch etc. Digital Pulsed Inputs are compatible with digital hall effect based sensors, have a maximum input voltage rating of 25VDC and can measure up to 50KHz Maximum frequency.

**\* DPI #2 available to Elite 750 ECU only.**

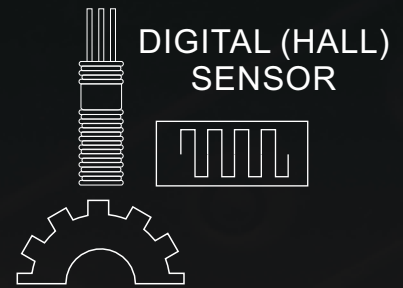
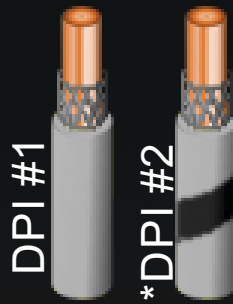

# MAP SENSOR

## On-board Pressure Sensor

### OVERVIEW

The MAP sensor is used to convert the manifold pressure into an electrical signal for the ECU to use. The internal Manifold Absolute Pressure Sensor is a 3Bar sensor which is rated up to 200kPa of boost (2Bar / 29psi). Connect the sensor to the inlet manifold via the shortest possible length of vacuum hose and fasten with either hose clamps or nylon cable ties. Avoid connecting the vacuum hose below the level of the fuel injectors, because fuel may collect in the vacuum hose and run down into the sensor causing the sensor to read incorrectly or fail.



# DPO

## DIGITAL PULSED OUTPUTS

### OVERVIEW

Digital Pulsed Outputs are capable of producing pulsed waveforms with varying duty and frequency.

DPO's can be used to control various devices such as thermo fans, shift lights, bypass air control valves, boost control solenoids etc. When a Digital Pulsed Output is activated by the ECU the output will switch to ground. Solenoid valves and shift lights etc can be run directly from the output, however high current devices such as thermo fans and additional fuel pumps must be activated through a relay, this way the DPO is only switching a relay and not a high current draw device.

The Pull-Up Voltage specifies the waveforms maximum voltage output ie 0 to 12V, 0 to 8V or 0 to 5V.

The Pull-Up Voltage specific to each DPO is outlined below:

DPO 1: User definable 0-12V Pull-Up

DPO 2: Fixed 5V Pull-Up

DPO 3 to 5: Fixed 12V Pull-Up

### OUTPUT: Ground @ 1A Max Current

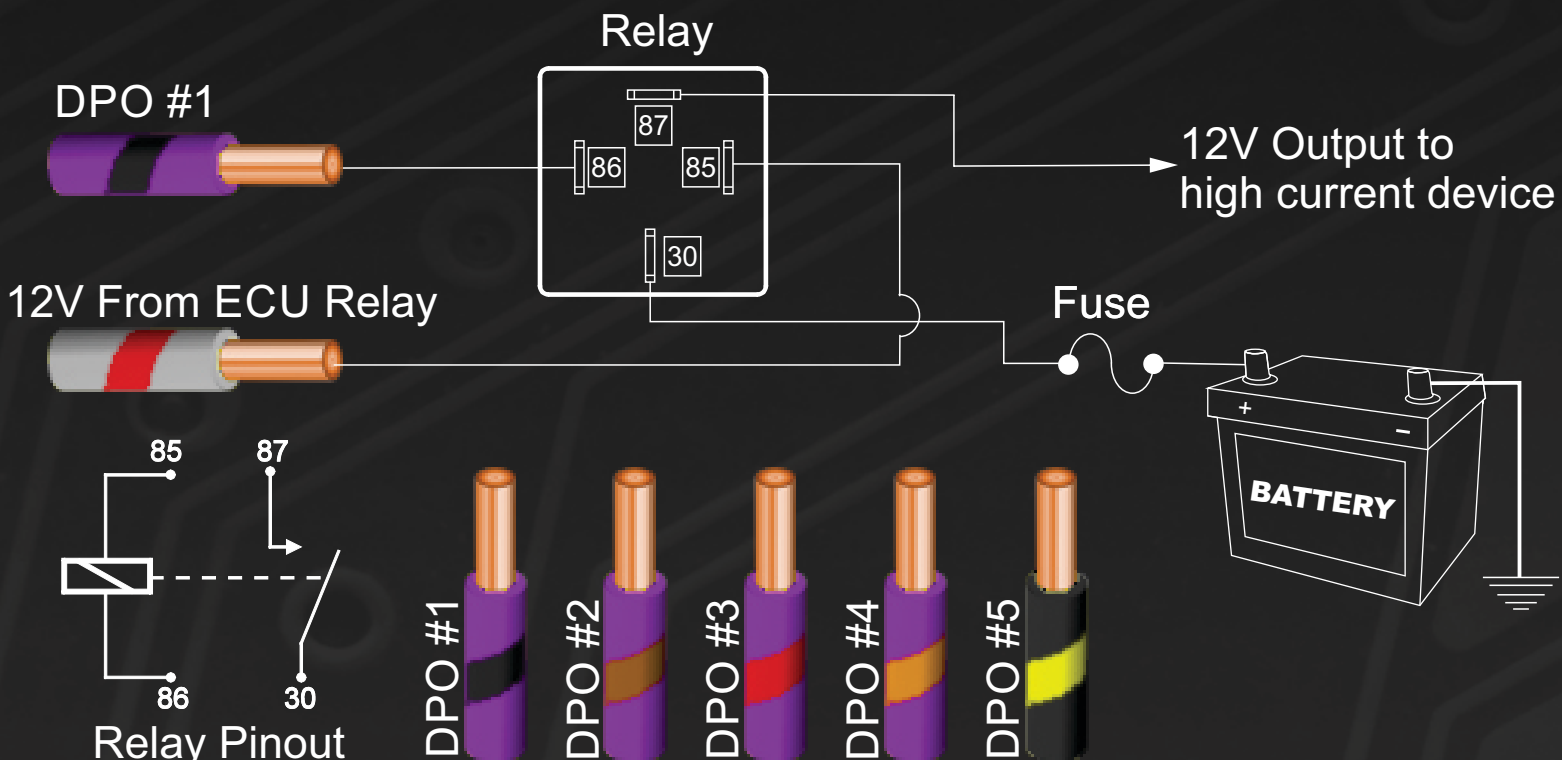

# IGNITION

## IGNITION 1 - 6

### OVERVIEW

Ignition outputs must be connected directly to an ignition module to control the ignition of the vehicle. Do not connect directly to a coil without an internal or external ignition module as doing this will damage the ECU.

The ECU ignition output produces a signal between 12V and ground to control the ignition module allowing the charging and firing of the coil.

### WARNING

Connecting the ECU to an ignition module before setting the ignition firing edge correctly may damage the module and coils, therefore it is advised to disconnect the module or the main ignition fuse until the unit has been setup and configured.

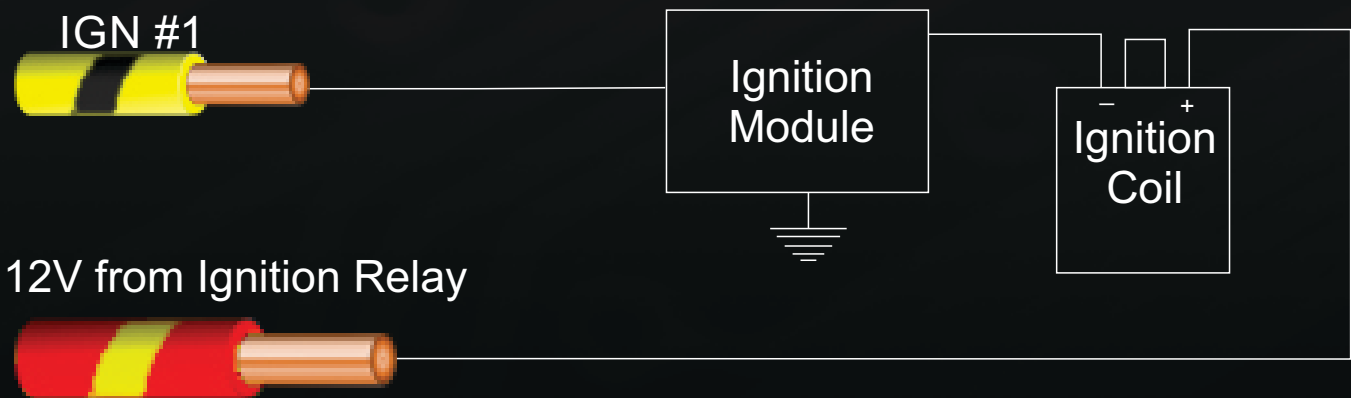

**\* IGN #5 / IGN #6 available to Elite 750 ECU only**

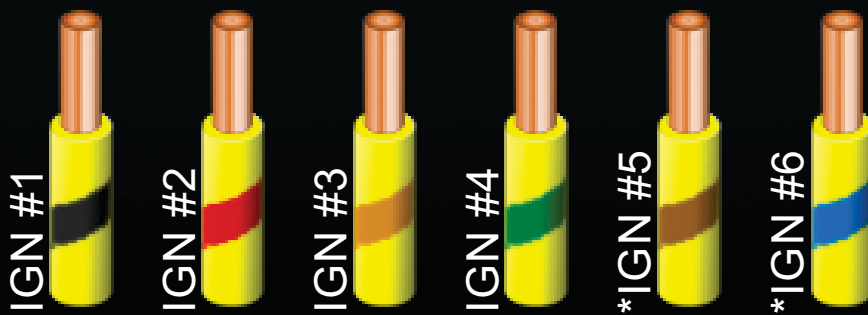

# INJECTION

## INJECTORS 1 - 6

### OVERVIEW

All Injectors are wired directly to the ECU's corresponding cylinder output pins. When an injection event occurs the ECU will ground the output pin opening the injector.

All injectors are required to be wired to a common +12V supply preferably from an injector relay located within the fuse box of the vehicle or the haltech premium harness.

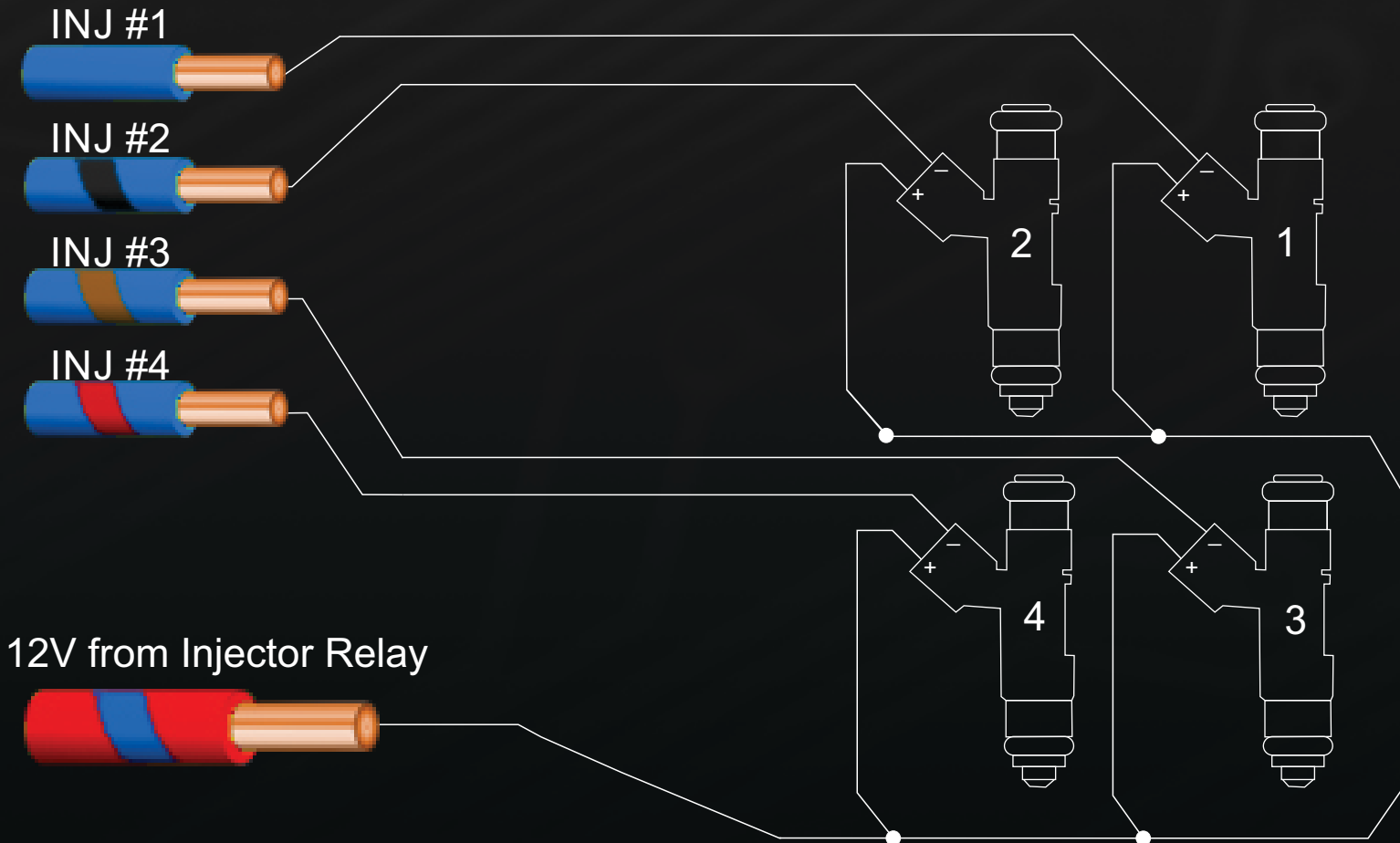

**\* INJ #5 / INJ #6 available to Elite 750 ECU only**

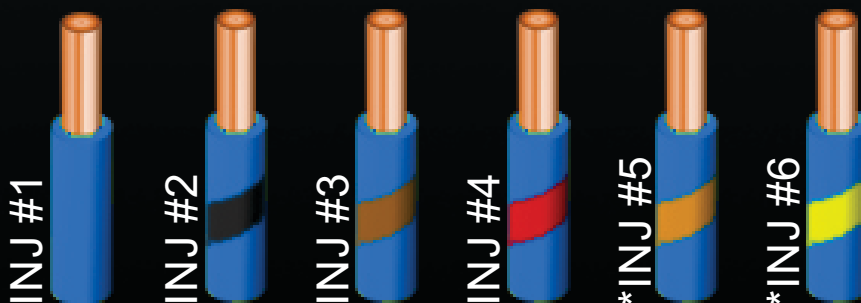

# ECU PINOUT

## ELITE 550 / 750 PINOUT

### OVERVIEW

The Elite 550 / 750 main connector is a 34 position connector. Pinout is outlined below.

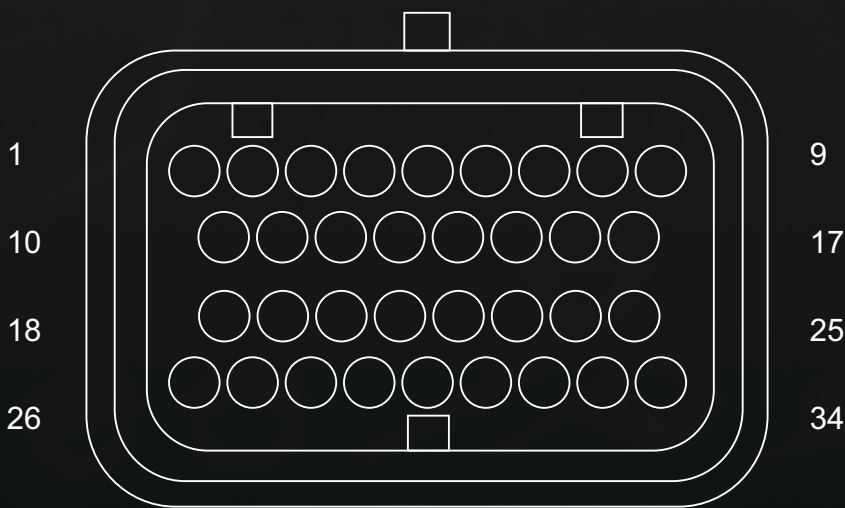

Looking into ECU Connector

Pin #	Wire Colour	Connection
1	V/BR	DPO 2
2	GY/Y <SHD>	AVI 1
3	Y/B	IGN 1
4	Y/R	IGN 2
5	Y/O	IGN 3
6	Y/G	IGN 4
7	Y/BR	IGN 5 (ELITE 750 ONLY)
8	Y/L	IGN 6 (ELITE 750 ONLY)
9	O	+5V DC
10	B	BATTERY GROUND
11	B/W	SIGNAL GROUND
12	GY <SHD>	DPI 1
13	GY/B <SHD>	DPI 2 (ELITE 750 ONLY)
14	W	THROTTLE POSITION SENSOR
15	Y	AVI 3 (* MAP)
16	W	CAN H
17	L	CAN L
18	V/B	DPO 1
19	L	INJ 1
20	L/B	INJ 2
21	L/BR	INJ 3
22	L/R	INJ 4
23	V/R	DPO 3
24	B/Y	DPO 5 (* Fuel Pump Relay)
25	V/O	DPO 4
26	R/L	+12V ECU / INJECTOR PWR
27	L/O	INJ 5 (ELITE 750 ONLY)
28	L/Y	INJ 6 (ELITE 750 ONLY)
29	GY	AIR TEMPERATURE
30	V	COOLANT TEMPERATURE
31	Y (GY 4C)	TRIGGER +
32	Y (GY/B 4C)	HOME +
33	G (GY 4C)	TRIGGER -
34	G (GY/B 4C)	HOME -

\* Allocated to, but not limited to specified function

# MAIN POWER









## POWERING UP THE ECU

### OVERVIEW





The Elite 550 / 750 has two universal wiring harnesses available. A Premium Harness which includes a pre terminated fuse and relay box and a Basic Harness which does not.

Please refer to your specific harnesses wiring diagram for more information, main connections are outlined below.

### Premium Universal Wiring Harness #HT-140604

-  12V Input - Connect directly to battery + terminal
-  12V Input - Connect directly to battery + terminal
-  12V Ignition Input - Connect to 12V switched input
-  12V Supply for Fuel Injectors - Connect to fuel injectors
-  Battery Ground Input - Connect to battery - terminal
-  Signal Ground Output - To sensors requiring a ground
-  5V Sensor Supply - To sensors requiring 5V
-  12V Sensor/Relay Supply - To sensors or relay coils requiring 12V

### Basic Universal Harness Only - #HT-140602

-  12V Supply for ECU - Connect to switched main relay supply
-  Battery Ground Input - Connect to battery - terminal
-  Signal Ground Output - To sensors requiring a ground
-  5V Sensor Supply - To sensors requiring 5V

# NEED MORE HELP?

Technical Support Australia (Head Office)

Email: [support@haltech.com.au](mailto:support@haltech.com.au)

Phone: +61 2 9729 0999

Technical Support USA

Email: [usasupport@haltech.com](mailto:usasupport@haltech.com)

Phone: +1 760 598 1941



**SCAN THIS CODE**  
For more information  
on Haltech products

